

Camera-Equipped Mini UAVs for Wilderness Search Support: Task Analysis and Lessons from Field Trials

Julie A. Adams, Joseph L. Cooper, Michael A. Goodrich, Curtis Humphrey, Morgan Quigley, Brian G. Buss, and Bryan S. Morse

Abstract—Wilderness Search and Rescue (WiSAR) is a complicated problem requiring thousands of hours of search over large and complex terrains. Using mini-UAVs to support WiSAR has the potential to dramatically improve search efficiency. In this report, we present the results from a goal-directed task analysis and a partial cognitive work analysis of the WiSAR problem. The results of these analyses is translated into a set of tasks that emerge when a mini-UAV is introduced into the WiSAR domain. Given these tasks and a set of technologies that provide fundamental support for the tasks, we report the results from a series of field trials. These field trials indicate the need to improve video presentation and to coordinate UAV resources with ground search resources.

I. INTRODUCTION

THE terms *Uninhabited Aerial Vehicle* (UAV), *Unmanned Aerial Vehicle*, and *Autonomous Mini Air Vehicle* (AMAV) are frequently used to denote aircraft that do not have humans on board [5, 18]. Unfortunately, each of these terms is defined by the absence of an onboard pilot and fails to emphasize the obvious fact that such aircraft are controlled, to some degree or another, by humans. The term *Remotely Piloted Vehicle* (RPV) is sometimes used in place of UAV, but this term fails to emphasize the important role of onboard autonomy in modern UAV control [5, 44]. In this paper, we use the acronym UAV, but emphasize the joint roles of autonomy and human interaction.

The exact type of interaction between a human and onboard autonomy varies widely across UAV platforms. At one extreme, the Predator UAV, operated by the

United States Air Force, essentially re-creates a traditional cockpit inside a ground-based control station, complete with stick-and-rudder controls. At the other extreme are architectures employed by research UAVs that measure atmospheric composition by flying pre-programmed flight paths to obtain precise scientific data [21]. The interactions represented by these two extremes typify Sheridan’s descriptions of teleoperation and supervisory control, respectively [41, 42].

The presence of these extremes illustrates a key point: the design of an operator interface and the UAV autonomy is essentially a problem of human-robot or human-machine interaction, and a “catch-all” solution for all aircraft and all applications is unlikely to emerge. UAV human interaction design is fundamentally interrelated with UAV autonomy design, and is essentially a multi-dimensional trade-off between precision, response time, neglect tolerance, portability, and team size [11, 36]. To help system designers balance these tradeoffs, it is desirable to develop autonomy and operator interfaces that span multiple application domains as much as possible.

The capabilities of a particular combination of airframe, autopilot, and control algorithm delineate the set of *affordances* that frame the human-UAV interaction space [20, 27] and the set of *constraints* on the kinds of tasks that can be performed. These affordances implicitly define the possible control modalities available for human interaction. Although each UAV application further adds a unique set of constraints that define the feasible portion of the interaction space, general observations can be made regarding the characteristics of various operator interfaces and UAV autonomy. Application constraints, especially human factors considerations, can then be used to eliminate infeasible interaction modes. In this paper, we will use an approach that employs concepts from various frameworks including “activity-centered design” [28], “goal directed task analysis” [16], and “cognitive

M. A. Goodrich and B. S. Morse are with the Department of Computer Science, Brigham Young University, Provo, UT, USA. C. Humphrey (graduate student) and J. A. Adams (faculty) are with the Electrical Engineering and Computer Science Department at Vanderbilt University. M. Quigley and J. L. Cooper were graduate students and B. G. Buss was an undergraduate student in the Department of Computer Science, Brigham Young University when the work was performed.

work analysis” [45] to design operator interfaces and autonomy appropriate for a specific application and for specific end users. We claim that this blend of techniques yields design concepts that support a human performing the search.

This technical report explores the problem of wilderness search-and-rescue (WiSAR) using mini-UAVs and small operator interfaces for controlling the UAV. Throughout the report, input has been received from volunteers and subject matter experts from Utah County Search and Rescue [29]. Although we will focus on the search phase of wilderness search-and-rescue, much of the following analysis can directly apply to military and other civilian surveillance and reconnaissance applications.

The report is outlined as follows. After surveying literature, we report results of a goal-directed task analysis and a cognitive work analysis, resulting in a task breakdown for UAV-enabled WiSAR. Results from a cognitive work analysis are then presented, with an emphasis on the type and flow of information used in WiSAR.

II. RELATED LITERATURE AND PREVIOUS WORK

There is a great deal of current research dealing with the human factors of UAVs. This work usually requires that the UAV have some level of autonomy. As appropriately designed autonomy increases, the following are desirable attributes of aircraft operation that may also be produced:

- Higher neglect tolerance [11].
- Decreased operator workload [41].
- Better fan-out ratios [14].

However, autonomy has the potential of introducing numerous negative attributes as well. For example, autonomy can result in:

- Reduced situational awareness [3].
- Difficulty in supervising autonomy [41].
- Increased interaction time [11].
- Increased demands on humans and autonomy, the “stretched system” effect [48].

Shifting from conceptual to hardware considerations, the experimental UAVs used in this work are small and light, with most having wingspans of approximately 42”-50” and flying weights of approximately 2 pounds. The airframes are derived from flying wing designs, are propelled by standard electric motors powered by lithium batteries. The autopilot is built on a small micro-processor, and is described in [5]. The standard sensor suite of the aircraft includes:

- 3-axis rate gyroscopes,
- 3-axis accelerometers,
- Static and differential barometric pressure sensors,
- GPS module, and
- Video camera on a gimballed mount.

The test aircraft utilize 900 MHz radio transceivers for data communication and an analog 2.4 GHz transmitter for video downlink. To reduce the risks associated with autonomy while still taking advantage of some of autonomy’s benefits, we adopt the hierarchical control system described in [5]. Higher levels include path-generation and path-following algorithms, and lower levels include attitude and altitude stabilization [35].

Typically, UAVs engaged in a search task either require two operators or a single operator to fill two roles: a pilot, who “flies” the UAV, and a sensor operator, who interprets the imagery and other sensors [44]. It is sometimes useful to include a third person to monitor the behavior of the pilot and sensor operators, and serves to protect them and provide greater situation awareness [7, 9].

In this paper, we explore how a suitable operator interface and sufficient UAV autonomy can simplify the two roles to the point that one operator can fill both roles simultaneously or alternately. This objective is an emerging theme in the human-centered robotics literature [14, 22, 30, 31]. Although this objective increases the responsibility of a single operator, it can decrease the communication and coordination workload associated with team activities and may therefore reduce the potential for misunderstanding. The goal is to support fielded missions in the spirit of Murphy’s work [7, 9], but to focus on different hardware and operator interface designs in an effort to complement and extend existing designs.

In the WiSAR domain, literature related to aerial search is particularly relevant. In the classical studies on search theory, one critical factor in designing an optimal search is determining the *instantaneous probability of detection by one glimpse* [25]. If the observer must make a target classification decision in real-time, the search must progress slowly enough that the observer has time for enough “glimpses” of the potential target to obtain a satisfactory probability of detection. The goal of 100% target detection is in continual conflict with the goal of searching the largest area possible, and finding a satisficing resolution of a tradeoff [41] must be reached to enable searchers to cover a wide area of the target zone while maintaining an acceptable target detection rate.

Because the study of UAVs is a relatively new domain, it is useful to perform human factors analyses of domains where UAVs can be used. This paper includes such analyses in the form of both goal-directed task analysis [17] and cognitive work analysis [45]. Cummings [12] created an extended version of CWA (mCWA) for application not only to causal systems but also to intentional systems. mCWA introduces two additional steps: analysis of global social, organizational, and ethical factors; and the creation of a simulated domain. In general, both the mCWA and CWA processes provide an understanding of the socio-technical context in which workers perform tasks [45]. mCWA has been applied to naval warfare [13] and CWA has been applied to a number of domains including emergency management [45]. Naiker et al. [26] modified CWA for the design of teams by conducting a work domain analysis, an activity analysis, and a tabletop analysis to ascertain the feasibility of the proposed team designs. Part of a CWA is a work domain analysis (WDA). This paper differs from most applications of WDA in that we are applying it to a human based system rather than a mechanical system.

A relatively recent method for presenting spatial information involves the use of computer graphics techniques to present a synthetic or virtual environment. Multiple studies in both the manned and unmanned aviation domains have compared displays in many different configurations and concluded that different perspectives are appropriate for different tasks [1, 8, 34]. Of particular relevance is Drury's paper on using synthetic vision in a search-related task similar to the WiSAR task described herein [15]. In another study, the authors compare 3-D with 2-D viewpoints in an aviation task [46]. Ultimately, all synthetic environment displays are a 2D projection of a 3D space, so it may be that two or more perspectives, with the possibility of switching between them, are necessary to provide sufficient situation awareness to support a WiSAR task.

Finally, it is important to note that the analysis in this paper relies heavily on seminal work in human factors, aviation, situation awareness, etc. [16, 41, 42, 47]. Of particular relevance is the levels of autonomy presented in [43] and extended to more general types of automation in two other important papers [24, 32]. This paper emphasizes control and display autonomy, leaving sensing and decision-aiding autonomy to future work.

III. FUNDAMENTAL WiSAR ACTIVITIES: WiSAR TASK ANALYSIS

One of the initial steps in developing a WiSAR system is the identification of the fundamental activities that can be performed autonomously by mini-UAVS. This paper reports results from two task analysis techniques: Goal Directed Task Analysis [17] and Cognitive Work Analysis [12, 45]. The Utah Country Search and Rescue subject matter experts provided information and reviewed the analysis results. We use the results from the goal-directed task analysis to identify what tasks can be delegated to a UAV, and then use the cognitive work analysis to identify information requirements that influence the design of an operator interface.

The Goal Directed Task Analysis (GDTA) was performed in order to understand the wilderness search process by identifying the user's goals, decisions, and ideal information requirements. GDTA is not bound to the current system, and permits identification of potential system improvements. The GDTA has four stages: goal hierarchy development, conducting interviews, developing the goal-decision-SA (situation-awareness) structure, and obtaining feedback.

The GDTA identified six unique high-level WiSAR goals along with a number of subgoals, decision questions, and information requirements. The overall GDTA is summarized in Figure 1 and a detailed breakdown is presented in Figure 2. This detailed breakdown emphasizes that the overall goal is the rescue or recovery of the mission person.

The first responders have three priorities that they strive to achieve. The first priority is their own personal safety. This is an inherent priority for all first responders and is therefore not represented as a goal in the GDTA. If conditions permit, the second priority is to locate and rescue the missing person. If the rescue fails, the third priority is to locate and recover the missing person. These two final priorities are represented by the overall GDTA goal of rescue/recovering the missing person.

This paper's focus is on developing UAV capabilities to support more efficient WiSAR with less risk exposure to the human responders. Therefore, emphasis is placed on the search plan (goal 3.0) and executing the search plan (goal 4.0) goals. For completeness, a brief overview of the stage preparation goal (goal 1.0), acquisition of the missing person description goal (goal 2.0), recovery goal (goal 5.0), and debriefing goal (goal 6.0) is provided.

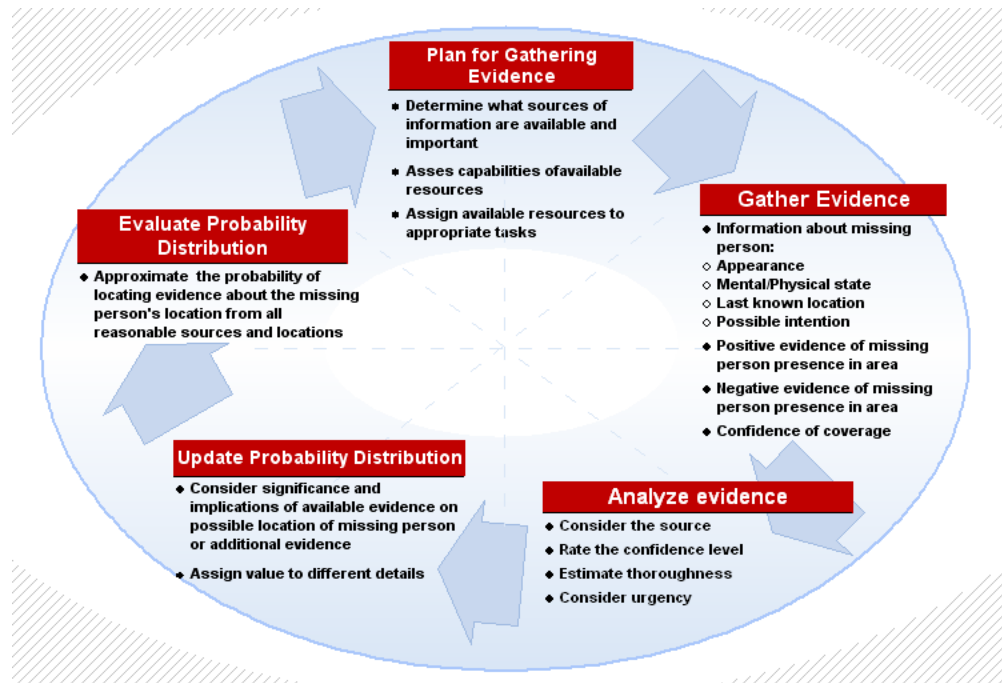

Fig. 1. Information flow in the WiSAR domain.

A. Stage Preparation - Goal 1.0

The WiSAR process begins when someone grows concerned over a missing friend or relative. This person, known as the reporting party, contacts the appropriate authorities (such as a 911 call center), as represented by goal 1.0 Stage Preparation, in Figure 2. The recipient of the phone call must collect the incident information (goal 1.1). The recipient of the phone call attempts to determine from the reporting party where the missing person was last seen, a description of the missing person, and the reporting party's contact information. The call recipient then determines who should be contacted based upon the chain of authority and places an activation call (goal 1.2).

Once the activated individuals are assembled, they assess the nature of the incident, where the incident scene is located, potential environmental conditions, and what equipment is required for the response (goal 1.3). The assembled personnel deploy additional necessary personnel, including WiSAR personnel to the incident scene assembly point. If the call goes to the WiSAR team, the responder team, which is primarily composed of volunteers, arrives at a predetermined site and sets up a command center.

B. Missing Person Description - Goal 2.0

While the responders are organizing at the assembly point, additional personnel collect the details of the potential incident and missing person; see goal 2.0 *Acquire Missing Person Description* in Figure 2. Authorities locate and question the reporting party in order to verify the information obtained from the reporting party by the call recipient (goal 2.1). Authorities will also obtain additional information from the reporting party and other relevant individuals (e.g. family and friends) in order to obtain details on the missing person's clothing, appearance, and possessions (goal 2.1) for the missing person profile see Figure 3. Such information is very important in assisting the searchers when analyzing possible sightings and clues. Equally important are the missing person's personality, mental and physical health, intentions, experience with the terrain, last known direction of travel, and any other information that may provide an indication of what the missing person's reaction will be given the situation. This information is employed to develop a missing person profile that is used by the searchers to determine what to look for and where to look.

The incident commander and responders must compile their assumptions regarding the missing person's intent

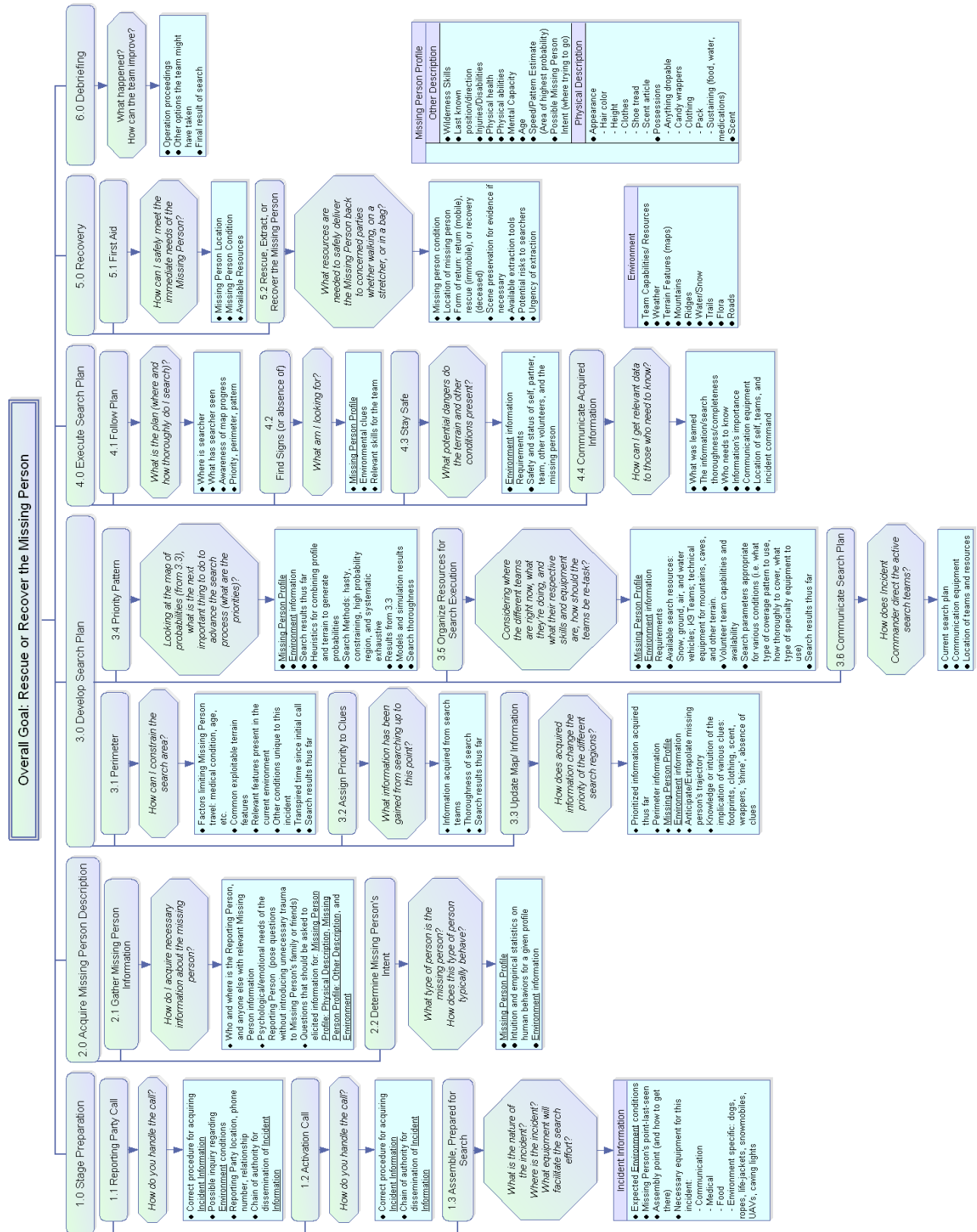

Fig. 2. The overall WiSAR GDTA results for all high-level goals.

Missing Person Profile	
	Other Description
●	Wilderness Skills
●	Last known position/direction
●	Injuries/Disabilities
●	Physical health
●	Physical abilities
●	Mental Capacity
●	Age
●	Speed/Pattern Estimate (Area of highest probability)
●	Possible Missing Person Intent (where trying to go)
	Physical Description
●	Appearance
-	Hair color
-	Height
-	Clothes
-	Shoe tread
-	Scent article
●	Possessions
-	Anything dropable
-	Candy wrappers
-	Clothing
-	Pack
-	Sustaining (food, water, medications)
●	Scent

Fig. 3. The WiSAR GDTA Missing Person Profile information requirements.

Environment	
●	Team Capabilities/ Resources
●	Weather
●	Terrain Features (maps)
●	Mountains
●	Ridges
●	Water/Snow
●	Trails
●	Flora
●	Roads

Fig. 4. The WiSAR GDTA Environment information requirements.

(goal 2.2). These assumptions are formulated based upon the developed missing person profile, the environmental conditions (Figure 4), intuition, and statistics regarding human behavior.

C. Search Plan - Goal 3.0

The third goal for the WiSAR response requires the WiSAR team to develop a prioritized search plan; see goal 3.0, *Develop Search Plan* in Figure 5. The development of the overall search plan incorporates the six subgoals shown in Figure 5. The incident commander employs the search plan when determining how to deploy the available resources to perform the actual search.

1) *Establish perimeter - Goal 3.1:* The WiSAR team’s first objective is to determine, along with the incident commander, the search area perimeter. The intent is to constrain the search area based upon considering the missing person’s profile regarding physical health and limitations, wilderness skills, last known position and direction, and possessions as illustrated in Figure 3. Environmental factors (Figure 4) such as terrain, weather, etc. will directly feed into the determination of the perimeter. The perimeter decision is also influenced by the time that has transpired since the initial phone call and the search results obtain thus far (individuals typically conduct a limited search as soon as they determine someone is missing). The determination of the search perimeter plays a vital role in developing the search plan.

2) *Assign priority to clues - Goal 3.2:* As information is gathered and the search progresses, priority is assigned to the incoming information to determine its relevance. Since this search is an on-going activity, the assignment of priority to the gathered information will assist in determining how the search proceeds.

3) *Update map/information - Goal 3.3:* A search map is maintained throughout the search process. This map is updated as information is received and prioritized. Updating the map requires information pertaining to the search perimeter, the environmental conditions, the missing person profile, areas previously searched, and an anticipated or predicted missing person trajectory. The projection of the missing person’s trajectory through the defined search area is based upon the missing person profile and the environmental conditions. This updated map and information are then fed into the determination of the search priority pattern.

4) *Priority pattern - Goal 3.4:* The objective of establishing the search priority pattern is to identify the value of searching areas within the incident perimeter. The incident commander must factor the missing person profile and environmental conditions into a set of heuristics in order to determine probabilities associated with the areas within the search perimeter. An example of such a heuristic is the observation that an autistic child may move in an uphill direction whereas many other people will tend to move downhill. Probabilities are assigned to the search area in order to guide the final search plan development. The priority pattern requires consideration of the search thoroughness and results from models and simulations.

The level of search thoroughness may be represented as a probability of detecting the missing person or a sign of the person. It is necessary to specify the level of

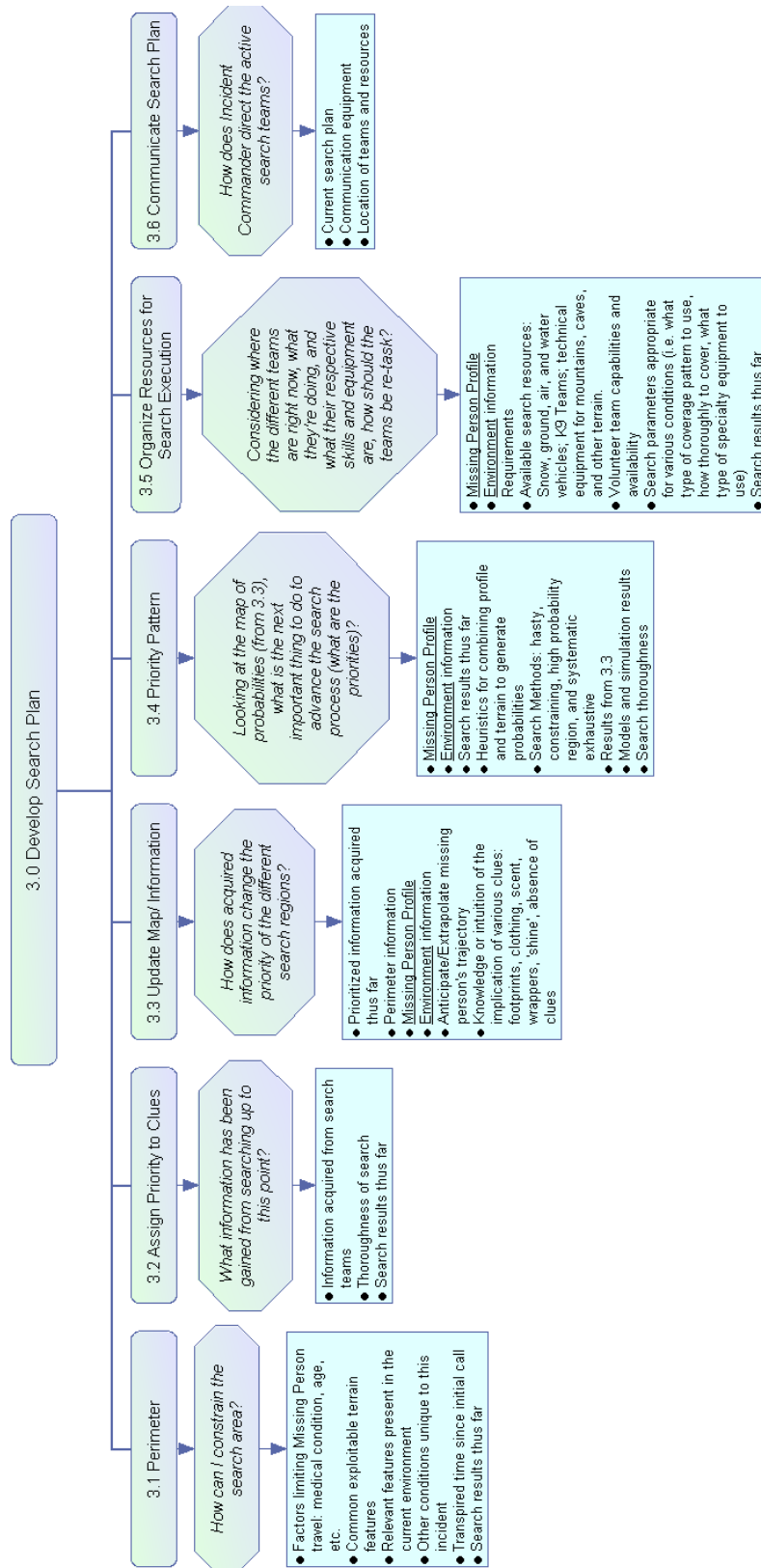

Fig. 5. The detailed WiSAR GDTA 3.0 goal - Develop Search Plan.

thoroughness since dedicating too much time and effort to one area prevents searchers from searching other areas within the perimeter. A coarse search technique may be possible if the missing person can hear, see, or call-out to searchers (a constraint that is not always satisfied with very old, very young, disabled, or injured missing persons [40]). Similarly, a coarse search may be possible if expected cues are easy to detect, such as knowledge that the missing person is wearing a bright orange rain coat.

The determination of the priority pattern is also dependent upon the possible search methods to be employed. Four qualitatively different types of search strategies¹ are used in WiSAR, they are:

- Hasty/heuristic,
- Confining,
- High probability region, and
- Exhaustive.

a) Hasty Search: WiSAR searches often begin with a *hasty search*, rapidly checking areas and directions that offer the highest probability of detecting the missing person, determining the missing person's direction of travel, or finding some clue regarding the missing person's location. This search is considered "hasty" because the longer the searchers wait, the lower the probability that this type of search strategy will yield useful information. The incident commander will often initially employ canine and "man-tracking" teams to follow the missing person's trail. This technique can be considered part of the hasty search. Additionally, a hasty search can facilitate the execution of constraining and priority searches by providing information regarding the missing person's possible location.

b) Constraining Search: The initial search efforts often include a *constraining search* in addition to the hasty search. The purpose of the constraining search is to find clues that limit the search area; this type of search is termed a "perimeter" search. As an example of the constraining search strategy, if there is a natural ridge with only a few passages, searchers will inspect the trails through the ridge for signs of the missing person in order to restrict their efforts to one side of the ridge or the other. It is important to note that every search strategy

¹Note that we use the phrase "search strategy" to indicate some form of informed method of executing a search. In [40], the term "strategy" is restricted "to the process of establishing a probable search area most likely to contain the subject" and the term "tactics" refers to "explicit methods used to deploy search resources into that area." Thus, in the parlance of [40], our use of the phrase "search strategy" would more accurately be referred to as "search tactics".

that fails to find the missing person or identify additional information does serve to constrain the search.

c) High Probability Region Search: Results from hasty and constraining searches are often used to inform search in *high probability regions*. As information from these searches and the likely behavior of the missing person becomes available, the command center divides the search area into sections. These sections are drawn onto maps that are distributed to the searchers as they arrive in order to provide a common language and frame of reference with which to chart the search progress. The incident commander can estimate the probability of finding the missing person in the various sections of the map based upon a combination of experience born of intuition, empirical statistics, consensus, and natural barriers [40]. The incident commander then deploys the search teams with the appropriate skills to examine the areas of highest probability. The search teams report their findings as well as an assessment of the thoroughness of coverage as they search an area. The reports allow the incident commander to revise priorities and reassign resources to different areas.

d) Exhaustive Search: As the search continues, the priority search turns into an *exhaustive search* with the incident commander directing the systematic coverage of the entire area using appropriate search patterns. An exhaustive search is typified by "combing" an area wherein searchers form a line and systematically walk through an area. Such a search typically indicates that other more effective search strategies have failed to yield useful information. Exhaustive searches may not find the missing person, but they can produce clues (such as discarded food wrappers or clothing) that indicate the presence of the missing person at some point in time. If the exhaustive search produces new information, the incident commander may return to a form of prioritized search.

5) Organize resources for search execution - Goal 3.5: The purpose of organizing the resources for the search is to determine exactly how the search should proceed. The search will change over time based upon employed search techniques and the information obtained via the search. The commander employs the missing person profile, the environmental information, the updated map (goal 3.3), the priority pattern (goal 3.4), knowledge of available search resources, WiSAR team capabilities, and knowledge of the search techniques to determine how to proceed.

6) Communicate search plan - Goal 3.6: Once the incident commander determines how to proceed, the

search plan must be communicated to the relevant individuals. Personnel may be waiting for instructions at the assembly point, or they may be actively searching. The commander requires the search plan, communication information and knowledge of the search teams' locations in order to effectively communicate the plan.

D. Execution of Search Plan - Goal 4.0

The incident commander assigns teams to a particular search technique and search area. The search teams are responsible for executing the search and they have four primary sub-goals, as shown in Figure 6. The search team is expected to execute the search plan (goal 4.1) while searching for evidence (goal 4.2), ensuring their personal safety (goal 4.3), and communicating their findings (goal 4.4).

1) *Follow Plan - Goal 4.1:* While following the search plan, the search team reports their progress to the incident commander; such reports may be at scheduled intervals and may be made indirectly through a hierarchical organizational structure. The searchers must also monitor their progress based upon the defined search area and an associated map. Frequently it is difficult for the search teams to completely satisfy the incident commander's requirements. Environmental elements such as water, weather, vegetation, and rugged terrain may force the searchers to deviate from the planned search. Moreover, the precise implementation of the search varies across teams due to challenges, such as available equipment and the technical skills of the searchers.

2) *Find signs - Goal 4.2:* Throughout the search process the team looks for evidence, or the lack of evidence, of the missing person's recent presence in the area. The team looks for items the missing person had in his or her possession, foot prints, natural disruption to the environment as individuals pass through it, etc.

3) *Stay safe - Goal 4.3:* Continuously throughout the search process the search team members' first priority is their own safety. There are a large number of potential hazards to the search team members that they must monitor based upon the environmental conditions and other conditions present in the area.

4) *Communicate acquired information - Goal 4.4:* As the team gathers information, they must make a determination regarding whether or not to communicate it to others. If the information needs to be communicated, searchers must determine to whom it should be communicated. The communication must include the actual information, an assessment of the information

importance, and perhaps an assessment of the teams' thoroughness when collecting the information.

E. Recovery- Goal 5.0 and Debriefing - Goal 6.0

The overall GDTA shown Figure 2 includes two additional goals representing the recovery of the missing person and a team debriefing. The recovery (goal 5.0) requires first aid to be administered to the missing person followed by the extraction, recovery, and rescue of the missing person. Extraction may involve technical search expertise, such as using ropes to remove a person from a hard to reach area. Extraction requires the missing person to be removed from a precarious location while recovery is simply accessing a missing person who is easily reached. The rescue involves transporting the missing person to safety. The team debriefing reviews the incident background, the WiSAR search process, and any suggested process improvements.

IV. CWA OF WiSAR

Although the GDTA provides a clear delineation of the situation awareness information requirements, it does not represent timing sequences. Therefore, the results of the GDTA are often difficult to apply directly to the design of an operator interface in support of the full process. A Cognitive Work Analysis (CWA) provides information regarding timing sequences and an understanding of the socio-technical context in which workers perform tasks. CWA is a constraint-based approach that provides an overarching framework yielding insight into unanticipated scenarios, although it does not focus on the situation awareness requirements.

The CWA process [45] is employed, in this context, to model a causal system. CWA consists of five stages: Work Domain Analysis (WDA), constraint based task analysis (CbTA), analysis of effective strategies, analysis of social and organizational factors, and identification of demands on worker competencies. A limited version of the CWA has been performed for this work focusing on the work domain analysis (WDA) and the constraint-based task analysis (CbTA), which has been conducted to guide the development of an operator interface supporting the WiSAR mission.

A. Work Domain Analysis

The first step of the CWA is a work domain analysis (WDA). The purpose of a WDA is to identify the functional structure within the domain by determining the information requirements necessary for handling

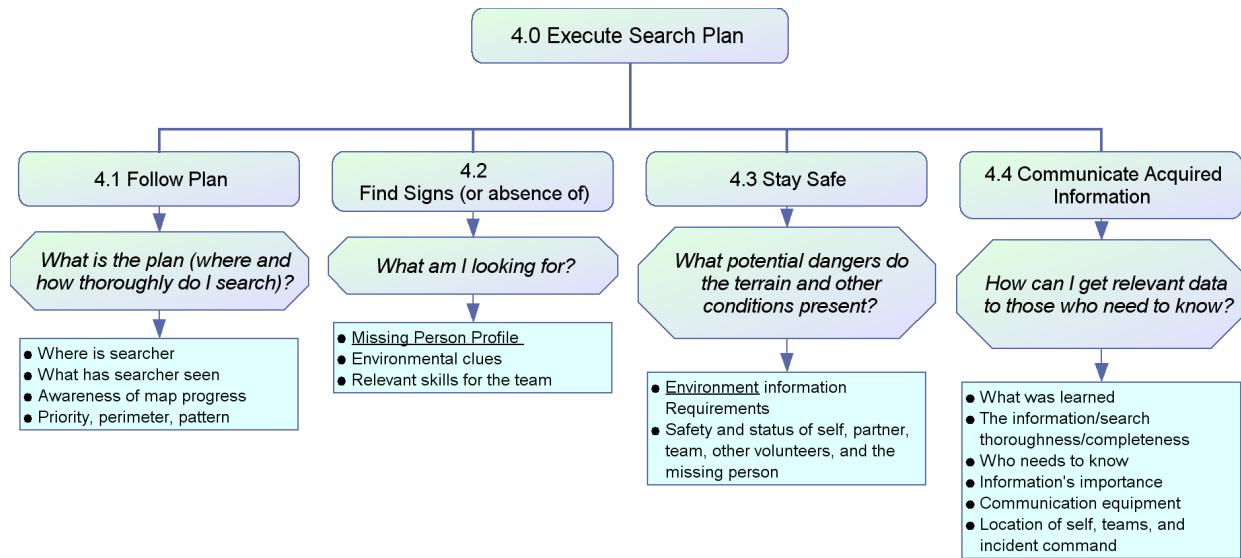

Fig. 6. The detailed WiSAR GDTA 4.0 goal - Develop Search Plan.

unfamiliar or unanticipated events [45]. The system being controlled represents the work domain. Note that the work domain does not focus on particular workers, technology, tasks, goals, or operator interfaces.

Work domain analysis is often represented graphically as an *abstraction-decomposition space* [45]. Abstraction decomposition focuses on understanding the relationships between subsystems and parts. The top of the abstraction-decomposition space represents a part-whole system decomposition. The abstraction-decomposition space for the WiSAR response is provided in Figure 7. The left-side of the decomposition represents the means-ends abstraction decomposition containing five levels that begin at the most abstract level and become more defined.

The representation of the WiSAR process as a system results in the identification of four abstract functions that represent sub-systems. These sub-systems represent the *safety* of the responders, *information acquisition*, *information analysis*, and the *rescue*. The information acquisition process incorporates the actual search process while the information analysis process, by contrast, is the process of evaluating information and (re-)planning the search. Information acquisition and analysis are the key abstract functions that must be managed by a human through an operator interface; thus, these two functions will receive most of the attention in this section.

According to the WDA process, the four abstract sub-systems are further decomposed into a hierarchical

representation consisting of the following elements: *abstract functional units*, *general functional units*, *process units*, and required *components* and *objects*. The decomposition identifies the work domain requirements and constraints that are to be satisfied when designing the human-UAV interaction.

1) *Safety*: The safety of responders incorporates the general functions of monitoring safety via predefined procedures and common sense. The responder safety is also determined by the teams' conditioning, training, equipment, and preparation.

2) *Information Acquisition*: The information acquisition function requires two functional units: the *search execution* and the *communicating information* functions.

The general functions associated with search execution are the four search techniques: hasty, constrained, high probability region, and exhaustive, as described in Section III. Each of these general search functions incorporates the processes of searching for signs of the missing person, covering terrain, and observing the terrain. Each of these processes, in turn, requires not only the actual search plan but also the appropriate technical equipment and training including the search plan. The *searching for signs of the missing person* process sometimes incorporates dogs; this process requires the missing person profile and the environmental profile. The *cover terrain* process incorporates maps of the search area, planes and helicopters, technical equipment, the missing person profile, and a profile of the environment. Finally,

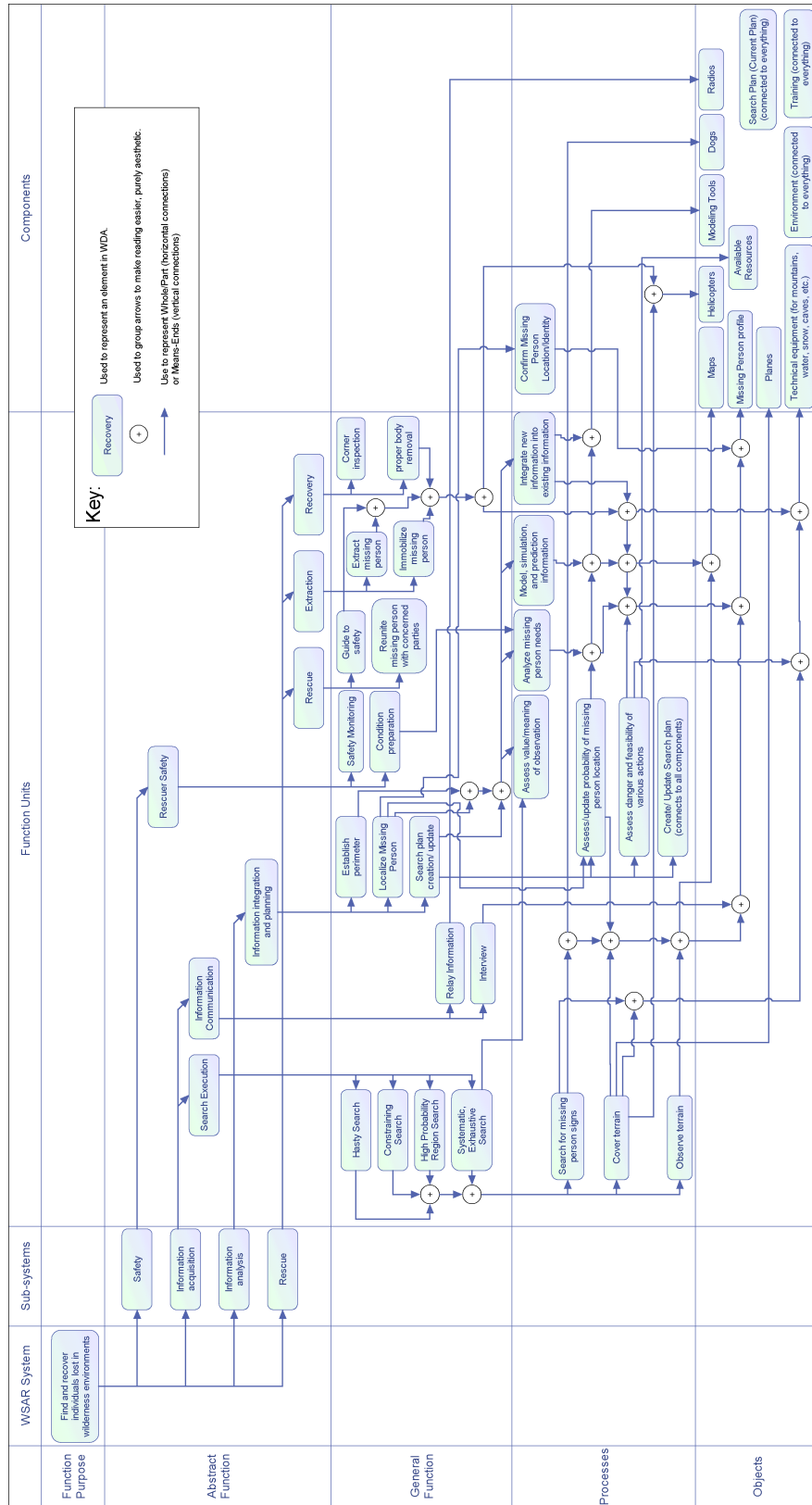

Fig. 7. The WiSAR Work Domain Analysis abstraction-decomposition space.

the *observing the terrain* process requires maps of the area, the environmental profile, and the missing person profile.

One general function associated with the communicating information function is interviewing relevant witnesses and bystanders. This function requires knowledge of the missing person profile and the environmental profile. The communication of information acquired via interviews (and communicating the search plan/progress) requires employing radios and knowledge of the environment, as the radios may not function in all areas, to relay the information.

3) *Information Analysis*: The information analysis function transforms incoming information into either a refined search plan or a rescue plan. Thus, information analysis may more concretely be defined as search planning. The search planning function is decomposed into the general functions of *establishing a search perimeter*, *localizing the location of the missing person*, and *developing/updating a search plan*.

Connecting the general function and process levels, the establishment of the search perimeter and search plan both require more concrete assessment of the value and meaning of the gathered information, integrating information into the maps and models, integrating model information, assessing and updating the probability of the missing person's location, assessing the danger and feasibility of various actions, and creating/updating a search plan.

Assessing and updating the probability of the missing person's location requires the missing person profile, the environmental profile, maps, modeling tools, and knowledge of the search plan currently being executed. The integration of the prioritized search information into existing maps and models requires the models and maps. The analysis of the missing person's needs requires knowledge of the missing person profile, the environmental profile, and maps of the area. The search process also involves the function of assessing and updating the probability of the missing person's location. This involves updating the models and maps based upon the missing person profile, the environmental profile, training, the modeling tools, and the current search plan.

The process of assessing danger and feasibility of potential actions requires knowledge of the missing person profile, the environmental profile, maps, technical equipment, available resources such as dogs, planes and helicopters, and personnel training levels/capabilities.

Finally, the information analysis function results in the creation of a search plan. The search plan requires all

the objects required for assessing potential actions along with the old plan. The old plan is then replaced by the current plan.

4) *Rescue*: The rescue sub-system is actually represented by three abstract functional units: *rescue*, *extraction*, and *recovery*. Extraction is further decomposed into extracting and immobilizing the missing person from a precarious position such as a crevice. Both of these functions require knowledge of the missing person profile, the environmental profile, training, and technical equipment. In some cases, it may also involve the use of a helicopter.

Recovery occurs when the person has not been rescued in time and has died as a result of exposure or injuries. Recovery is further decomposed into a coroner evaluation and the actual removal of the body. The removal of the body will require the environmental profile, technical equipment, personnel training, and possibly helicopters.

The rescue is decomposed into guiding the missing person to safety and reuniting the individual with concerned parties. Guiding the missing person to safety requires knowledge of the environmental profile, maps, and potentially technical equipment and helicopters.

B. Control Task Analysis

Although the WDA provides information pertaining to the work domain constraints along with an overall system perspective, it does not provide enough insight into the actions, information and relationships required for decision-making [45]. Such insight is necessary in designing an operator interface for the UAV search team, we must proceed to the second stage of the CWA, the control task analysis. The control task analysis is critical to identifying where new technology and systems may be used to support the search. We use a Constraint-based Task Analysis (CbTA) as the task-modeling tool employed for the control task analysis in this paper.

The CbTA represents the connection between an action and its goal via an action-means-end relationship [45]. This connection is the critical factor that determines how information is provided to a human via an operator interface to support a WiSAR mission. Thus, the CbTA provides the *information requirements* necessary for achieving goals in a flexible and situated manner for recurring situations. Importantly, the CbTA identifies what is to be done independent of any particular actor, thus implying that these requirements can be employed either by a traditional search team or to guide the formation of the WiSAR technology.

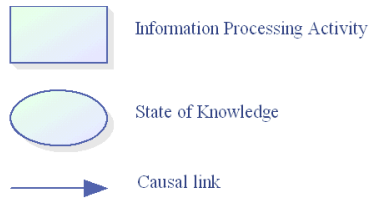

Wilderness Search and Rescue

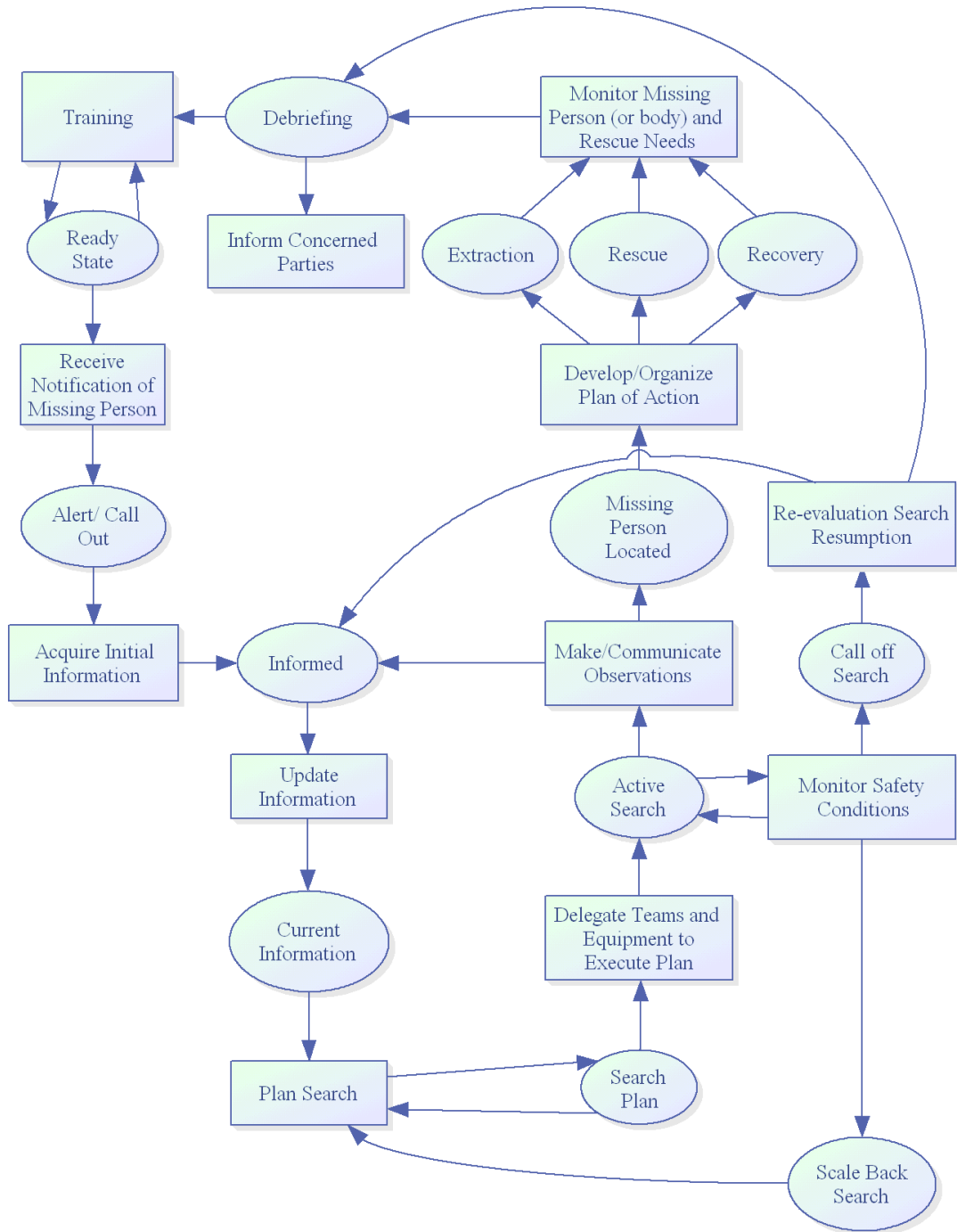

Fig. 8. The overall WiSAR constraint based tasks analysis decision ladder.

It is important that the information requirements are represented in a way that allows a designer to understand and respond to them. The typical means of representing the CbTA is a decision ladder. Figure 8 provides the decision ladder representing the overall WiSAR response. The rectangles represent the information processing activities and the ovals represent the state of knowledge that is obtained from the information processing. The arrows represent the process flow.

The WiSAR personnel begin the cycle with their training that places them in a state from which they are able to respond to an event. Upon receiving notification of a missing person, the appropriate WiSAR personnel are activated. Once on scene, the WiSAR personnel acquire initial information from the witnesses, family members, and bystanders. This information leads to updating the information pertaining to the missing person's whereabouts and results in current information that can then be employed to plan the search process. The result is a search plan that is delegated to WiSAR teams to execute. Throughout the search execution, the conditions are monitored for safety considerations and the search may be called off or scaled back at any time.

As information is acquired throughout the search process, it is communicated to the appropriate parties, including incident command. When new information arrives, the existing information is updated and the search plan may be modified and reissued.

The process of integrating incoming information with existing information, and the resulting updating or modifying the search plan, is quite involved. A more detailed decision ladder of these activities is provided in Figure 9.

The information processing activity leads to clues having priorities assigned to them and an updated priority pattern and map. As search teams complete their assignments, the information will lead to an update regarding the available search resources. The provided information will also provide current environmental conditions, an updated missing person profile, and the projected path of the missing person. The result is a set of current information that is employed to develop the search plan. The search plan development requires consideration of the four types of search: hasty, constraining, high probability region, and exhaustive based upon the most recent information.

When the missing person is located, their location must be communicated to the incident commander so that a plan may be developed based upon the situation: a trapped person will have to be extracted; a person who has perished will have to be recovered; and all other

individuals will be lead to safety and reunited with the appropriate concerned parties. Throughout the extraction and rescue activities, the missing person's needs are monitored.

Once the missing person is found and returned, a debriefing of all responding personnel is conducted. The debriefing serves two purposes. First, it serves to inform the concerned parties of the situation. Second, it serves as an assessment of what aspects of the process worked well or require improvement in the future. This process results in updating the training of the WiSAR personnel.

V. ACTIVITY ANALYSIS AND TASK BREAKDOWN

The introduction of UAV technology into the WiSAR domain must provide information as identified in the GDTA and CWA. When the results from these analyses is combined with existing technologies, a set of tasks emerge that must be performed to successfully complete a UAV-enabled wilderness search. This section discusses these tasks.

A. UAV-Enabled WiSAR: Task Breakdown

There are a number of different consequences that must be considered when integrating a new technology into the existing WiSAR process. These consequences include new responsibilities imposed on the searchers, shifts in responsibilities for the searchers, modifications of and integration into existing processes, and changes in how information flows.

UAV-enabled search is an enormously complex activity requiring closely integrated human interaction with both the operator interfaces and on-board autonomy. Figure 10 provides a task-breakdown of UAV-enabled WiSAR. This breakdown was obtained by combining results from the GDTA, observations from field tests, and an activity analysis patterned after the frameworks in [28, 32, 43]. This breakdown identifies three new responsibilities for the WiSAR search personnel: monitoring the UAV, deployment of the UAV, and retrieval of the UAV. Maintaining the UAV is a fourth new responsibility, but we omit a discussion of this responsibility in the interest of space.

The task breakdown in Figure 10 uses the terms "Search for Evidence" and "Constrain Search" to represent search-related tasks that have been altered by the introduction of UAVs. Sections V-C and V-D discuss these two tasks. Prior to doing so, we briefly discuss deployment, retrieval, and monitoring.

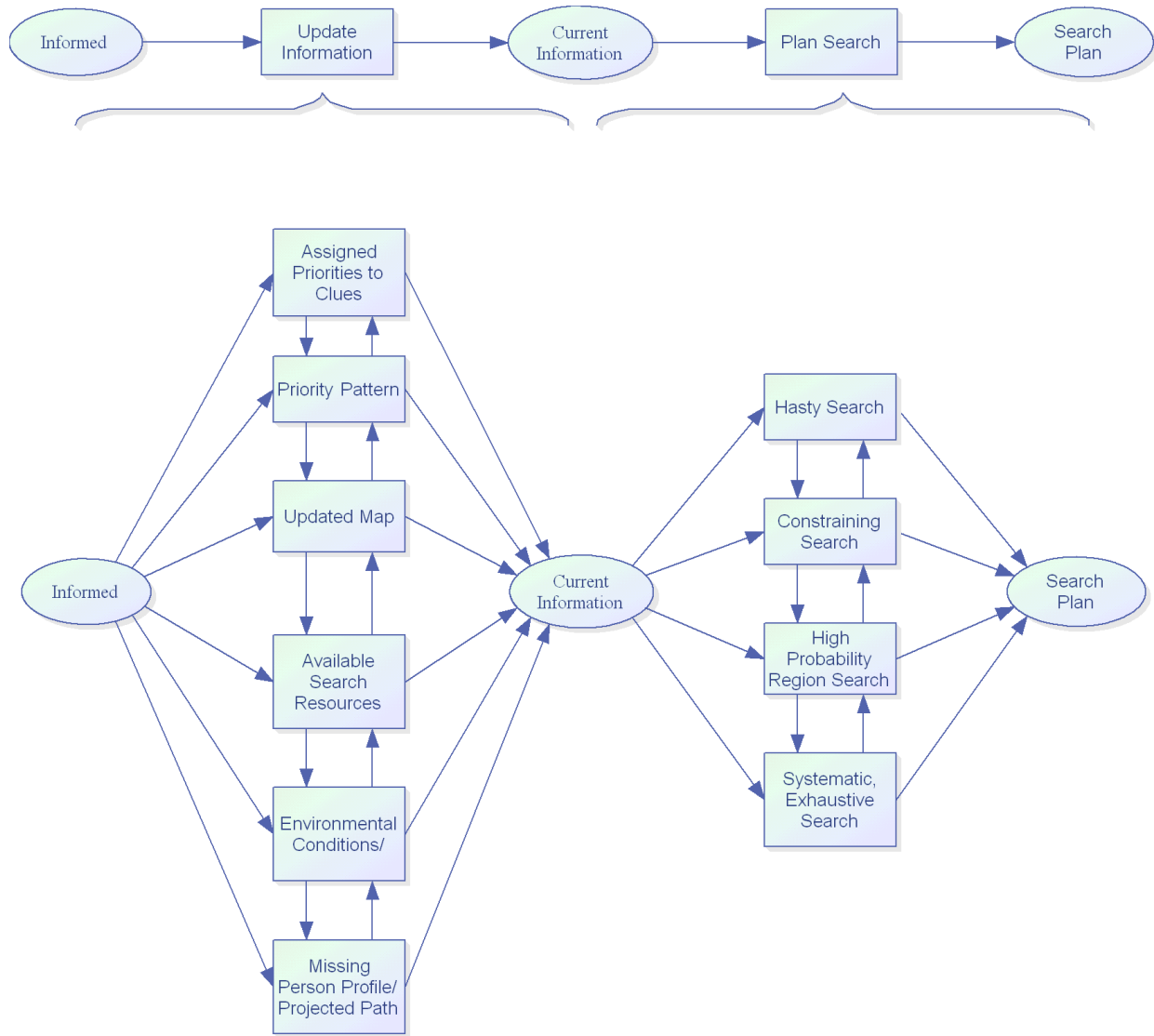

Fig. 9. The constraint based tasks analysis decision ladder for developing a search plan.

B. Deployment, Monitoring, and Retrieval

When a portion of a task is automated, the responsibility of the human shifts from performing the task to managing the autonomy that performs the task [49]. This shift introduces new responsibilities for the human. The first set of design requirements delineate how these new responsibilities must be performed. These new responsibilities associated with UAV-enabled search include deploying, retrieving, and monitoring the health of the UAV.

1) *Deployment*: The deployment phase commences once the preflight steps are completed. The deployment

phase requires the UAV to take-off, climb to cruise altitude, and navigate to the point at which the search is to commence as identified in the GDTA from Section III. For example, the starting point for a hasty search will likely be the point the missing person was last seen.

Operator Interface. The deployment phase requires that the operator interface support preflight procedures, portray the relationship between the launch point and the search start point, and allow the operator to control travel between the launch and search start point. Preflight steps include checking all sensors and actuators, recording the home base GPS coordinates, and validating the proper

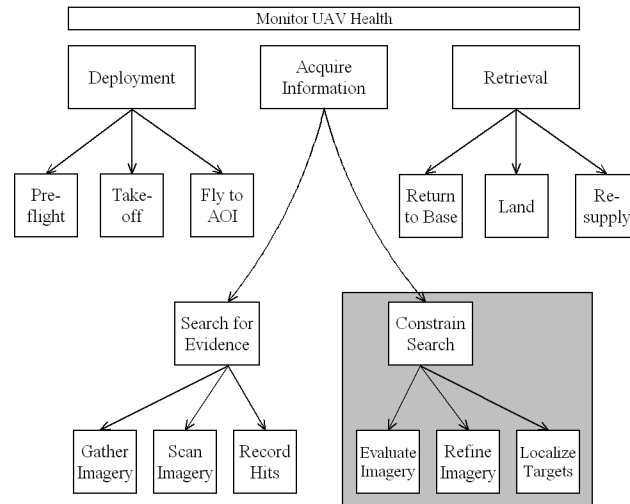

Fig. 10. Hierarchical task breakdown of UAV-enabled search.

setting of the controller parameters. The initial flight plan is then selected.

Autonomy. The initial flight plan typically consists of an autonomous spiral to the selected height (altitude) above the ground, at which point the UAV enters an autonomous loiter pattern until further instructions are provided [36]. During testing, an R/C² pilot is prepared to assume control of the UAV if problems arise.

2) *Monitoring:* Aircraft status anomalies, battery life, and other UAV health information must be efficiently communicated to the UAV operator. Since this information must be monitored throughout all mission phases, Figure 10 depicts the monitoring task spanning all other stages.

Operator Interface. The operator interface must allow the operator to confirm nominal behavior and to detect anomalies. The relevant information includes the status of communication channels, the existence or absence of a GPS lock, and remaining battery life. Attention management aides can assist the operator's attention allocation to status information, though this is a non-trivial problem since warnings and alerts can increase workload and disrupt critical control tasks [2, 39, 47]. Currently, the UAV health status is presented visually, though future work will explore the integration of audio and haptic cues as there is some evidence that these sensory channels can guide attention without overloading the visual channel [47].

Autonomy. The autopilot and ground control station employed in this work includes failsafe autonomy

²R/C = Radio Controlled.

modes. An example of such a failsafe mode occurs when communication with the ground station is lost for an extended time period, the UAV automatically returns to the home base (where communications are likely to be restored or an R/C pilot can assume control).

3) *Retrieval:* Similar to the challenges of deploying the UAV, retrieval is not a trivial task. UAV Retrieval requires navigating the UAV to the retrieval point; which can differ from the launch point or the home base. The retrieval point during WiSAR may shift locations due to changing weather conditions or discovering a location that better supports communications.

Operator Interface. The key pieces of information required for UAV landing includes a landing point and an approach vector that determines the direction from which the UAV flies to the landing point. Given the autonomy described in the next paragraph, the operator interface must support the human's ability (a) to identify a landing point and (b) to select an approach vector that is compatible with the terrain and weather conditions. The approach vector is selected such that the approach does not require the UAV to fly through trees. The operator interface should also present the UAV's last known GPS location in case the UAV crashes.

Autonomy. Landing has been addressed in [4, 36]. The UAV automatically flies to a GPS point that is an empirically selected distance from the landing point, then the UAV spirals down to a predetermined height above the ground. Upon reaching this height, the UAV breaks out of the spiral and flies the approach vector to the landing point.

C. Searching for Evidence

The introduction of new technology and the resulting new responsibilities imposed on the operator represent only one consideration. The new technology will also change the nature of how previous responsibilities are performed. Recall that the objective of the search process is to gather evidence regarding where the missing person is or, almost as valuable, where the missing person is not located. Without a UAV, this evidence is obtained by ground-based search teams or manned aircraft. With a UAV, locating a missing person via a UAV will require remote video feedback.

The basic steps for a successful UAV-enabled search include (a) aiming the camera to make it likely that visual evidence (either the missing person or some clue about the missing person) appears in the video, and then (b) identifying the evidence's location in order to guide the rescue team to the missing person. A successful rescue is characterized by rapidly locating a clue toward the missing person's location, since survivability drops as time progresses. In the remainder of this section, we use of the generic term "sign" to include any potential clue about the location of the missing person.

1) *Overview*: The objective of the searching task during a visual search is to obtain images in which a sign (at least theoretically) is visible by someone viewing the video. This subtask dominates the UAV's flight time and consists of three activities: gathering imagery, scanning imagery, and recording potential signs. The *gather imagery* activity is the fundamental obligation of this subtask and the UAV operator is responsible for directing this subtask. The *record potential signs* activity is necessary to support (a) offline image analysis and (b) localizing the sign for rescue teams. The *scan imagery* activity is not always necessary for completing an exhaustive search, but is necessary if the UAV's trajectory is reactively modified when a potential sign is visible in an image.

2) *Gather Imagery*: The gather imagery activity requires the UAV to fly in such a way as to acquire imagery of the search area. Imagery is acquired by planning a path, flying the UAV, and controlling the camera viewpoint to ensure that imagery is obtained of the *complete* search area. The speed and path of the camera's footprint over the ground are the key control variables [25], and the completeness and efficiency of the search are the key performance measures. The path should maximize the probability of locating a sign in the shortest possible time. This task can be simplified by introducing autonomous algorithms that systematically

implement the desired search plan.

3) *Scan Imagery*: Finding items of interest in the provided imagery is a surprisingly challenging task for an autonomous algorithm. Some search strategies, such as the hasty search strategy, require a human operator to reactively modify the UAV's flight path if a potential sign is found. Such reactive flights require at least a cursory analysis of the imagery so that the operator can view a potential sign, determine the sign's location relative to the UAV, and modify the UAV's path in response. Pixel density, field of view, image stability, and the contrast between sign and background are the key control variables; and the key performance variable is the probability of detection given that a sign is in an image.

4) *Record Potential Signs*: The UAV operator will make a preliminary classification of the imagery which will likely include recording potential signs as he or she scans the imagery. This task includes not only saving imagery for a more detailed analysis such as in the localization subtask, but also labelling the imagery with identifying information. This is clearly an action that can be simplified via a well-designed operator interface that allows images and features to be referenced to salient features of the real environment (such as GPS locations or significant landmarks). Potential signs are recorded in world coordinates and are then employed by ground searchers.

D. Constrain Search

Constraining the search is an important objective for UAV-enabled search. Finding the missing person effectually constrains the search area to a single point and allows for rescue or recovery, but finding a sign or changing priorities because no evidence is found is also an important constraint. Thus, constraining search includes two basic tasks: localizing a sign, and concluding that there is not sufficient evidence to justify continued search in a particular area. We will use the generic phrase *locating sign* to indicate both finding a sign as well as concluding that an area does not merit further search. Although automated target recognition technologies exist (see, for example, [37]), this paper restricts attention to sign detection performed by the UAV operator.

1) *Overview*: Locating a sign with a UAV requires three activities: analyzing imagery, localizing sign, and refining the imagery, which may require further imagery be acquired. The first two activities are the fundamental obligations of image analysis and the third activity is frequently necessary to validate a clue or localize a sign.

Note that the *constrain search* subtask is in a shaded region in the mission hierarchy shown in Figure 10. The shading indicates that this task is either performed simultaneously with sign sensing or performed at a later time. Note that this task may be performed either by the UAV operator or by a separate “sensor operator” [44].

2) *Analyze Imagery*: Imagery can be scanned either in real-time or offline using buffered video. Analyzing imagery with the goal of identifying the missing person’s physical location is the primary reason for obtaining the imagery, therefore this activity constrains and influences all other activity. The key variable for this activity is the probability that a human can detect a sign in an image given a set of image features. This probability is strongly influenced by the way information is obtained and presented. Effective image presentation requires supporting the image analyst’s reference frames, correlating map and video information sources through techniques such as tethers [33], and employing *a priori* information such as satellite imagery and terrain maps to provide context.

3) *Localize Sign*: Once a sign has been identified in an image, it is necessary to estimate the sign’s location so that searchers can reach the sign. Estimating the location is often referred to as “geo-referencing” the imagery. If the sign is the missing person, then the searchers must be able to reach the missing person’s location in order to complete the rescue. If the sign is a potential clue regarding the missing person’s location then searchers may wish to reach the clue in order to determine its relevance and to use it to inform the search process. Much of the sign localization activity can be performed autonomously employing the UAV’s GPS location, the UAV’s pose, triangulation, terrain information, and image features [38]. The provided operator interface must permit the operator to identify the sign’s features and activate the localization routines. Once a location estimate is obtained, the operator interface must present this information in a coordinate frame that allows searchers to reach the missing person.

4) *Refine Imagery*: Image refinement includes techniques that improve the human’s capability of identifying the sign, such as stabilizing an image, building a mosaic, orbiting a sign, presenting images in a map context, or obtaining images from different perspectives or at higher resolution [15, 19, 23]. These refinement activities can be classified into two loose categories: enhance obtained imagery and acquiring additional imagery. Such refinement can be employed to (a) improve the probability that an operator will see the sign, (b) categorize, prioritize, or discard a sign once a potential sign has

been detected, and (c) improve the estimate of the sign’s location. The operator interface capabilities required for this task should allow the operator to request a particular refinement process, such as executing a tracking routine. A reactive flight may require the UAV to fly multiple passes over a sign in order to obtain more images. The associated operator interface should present information that assists the operator while fly paths that support the image refinement.

VI. RESULTS FROM WiSAR FIELD TRIALS

It is important that the technology developed to support WiSAR be frequently evaluated in realistic field tests. Ultimately, these field tests should include participation by a full team of responders. As a step in this direction, we used UAV technologies described in [6, 35] and engaged in a sequence of field trials directed by a member of the Utah County Search and Rescue team, with the remainder of the UAV team consisting of student researchers including one student who is a trained search and rescue volunteer.

A typical field trial involves placing a dummy in the wilderness (see Figure 11) along with realistic clues.



Fig. 11. A “dummy” placed in an October 2006 field test.

A scenario, obtained from prior missing person case studies, is presented to the group. The incident leader then constructs a search plan and the UAV is used to execute this search plan insofar as possible. A series of field search trials were conducted in 2006 and 2007. Lessons from these field trials are presented in the next two sections.

A. Prioritization of Technology Development

The 2006-2007 field trials collected the rankings from seven participants that were assembled to identify important and high priority areas. Each person ranked ten different technologies from highest to lowest in *importance*

and *priority*. *Importance* indicates a subjective judgment of whether the technology is essential for a successful search. *Priority* indicates a subjective judgment of which technologies will become important in the future; priority is thus a judgement of which technologies should receive attention in the near future.

Ten different technologies were ranked from zero to nine, with zero being the least important and nine the most important. The technologies are:

- *Hard*: reliable UAV flight hardware, communications, and basic autonomy.
- *Intrfc*: user friendly operator interface.
- *Wpts*: algorithms for autonomously generating waypoints.
- *StVid*: operator interfaces that present stable video.
- *IntM/V*: operator interfaces that integrate maps and video.
- *HAG*: autonomy for maintaining height above ground.
- *Proc*: efficient coordination processes between operator, searchers, and incident commander.
- *ImEn*: enhanced imagery to highlight visual signs.
- *OffSrch*: operator interfaces that allow video to be searched offline.
- *GmbI*: A gimballed camera.

Although there are only seven biased judges evaluating the technologies, it is useful to perform some statistical analysis to establish some confidence about which technologies are particularly relevant.

Ranking data provides two types of data, one directly and one implicitly. The direct data set consists of pairwise comparisons between different technologies. If technology A is ranked higher than technologies B, C, and D, then we can safely conclude that the person doing the ranking held the following preferences: $A \succ B$, $A \succ C$, and $A \succ D$, where \succ is read as “is preferred to”. In other words, rankings directly provide an ordinal scale [10]. Nonparametric statistics are appropriate for ordinal data.

The implicit data set is related to the ratio of different technologies. If rankings are $rank(A) > rank(B) > rank(C) > rank(D)$, then the presence of technologies B and C indicates something of the preference strength that the judge has for A over D; the ratio of A’s utility to D’s is implied by the presence of technologies between A and D. Parametric statistics, such as z-intervals and t-tests, are appropriate for such ratio scales [10]. However, because the ratio scale is implicit and the number of technologies is small, we use a nonparametric analysis of the rankings.

For each technology pair, ξ_i and ξ_j , the hypothesis to be tested using the rankings is that ξ_i is more important than ξ_j . (Note that an analogous analysis is performed using the priority-based rankings.) The null hypothesis is that ξ_i is not more important (does not have higher priority) than ξ_j . The ranking data is a sample from a population of individuals who are qualified to judge whether ξ_i is more important than (has a higher priority than) ξ_j .

We need to translate the qualitative phrase “is more important (is higher priority) than” into a quantitative hypothesis. Since importance and priority are subjective judgements held by people, we quantify these terms using a strengthened form of majority rule that requires 60% of the population to make the same judgement. Thus, if more than 60% of the population judges ξ_i to be more important (have higher priority) than ξ_j , then we state that ξ_i is more important (has higher priority). Using these quantified definitions of importance and priority, we reject the null hypothesis if we can conclude that more than 60% of the population makes this judgment. Let q be the probability that a judge, randomly drawn from the population, will rank ξ_i higher than ξ_j .

We use statistical evaluation of the judges responses to evaluate the hypotheses. Although the sample of judges is composed of individuals who have thought deeply about UAV-enabled WiSAR, they are not randomly drawn from the general population and there is some bias in the rankings. These biases are spread approximately evenly across the technologies because the students are focused on different research topics. Since biases are approximately spread across the judges, we assume that the probability that each judge will rank ξ_i higher than ξ_j is independent of the rankings of all other judges. Judges did not see the rankings of other judges.

According to our quantified definitions of importance and priority, we reject the null hypothesis if $q \leq 0.40$; this means that if less than 60% of the population ranked ξ_i higher than ξ_j then we cannot reject the null hypothesis. We will translate this hypothesis into a test statistic over the judges; if too many judges rank ξ_i higher than ξ_j , we reject the null hypothesis. Let the test statistic N be the number of judges that rank ξ_i lower than ξ_j . N is distributed according to a binomial distribution with seven samples and parameter q . Given the threshold of the null hypothesis, $q \geq 0.40$, the probability that either six or seven of the randomly selected judges will rank ξ_i higher than ξ_j by chance is $P(N \geq 6) = 0.1586$. Thus, if six or seven judges rank ξ_i higher than ξ_j , then we reject the null hypothesis that

ξ_i is not more important (is not higher priority) than ξ_j with a confidence level of 0.1586. Note that this is not a high level of significance, but it is consistent with data that includes only rankings from seven judges.

Tables I-II present the number of judges that ranked the row technology, ξ_i , higher than the column technology, ξ_j . Significant differences in importance and priority are listed in bold. Table I identifies technologies that are considered important for the WiSAR application. The most important technology is hardware; this means that without a working UAV it is pointless to support WiSAR. Other important technologies include the ability to enhance raw video through stabilization, mosaicking, and image enhancement. The final two technologies judged to be important are the ability to autonomously maintain height above ground and the ability for the UAV and the entire WiSAR team to coordinate effectively.

Other technologies were not considered important. These include a user-friendly operator interface, support for autonomously generating waypoints, the ability to perform offline search, and an operator interface that integrates map and video. Given that the field trial scenarios and wilderness areas were selected to make it probable that short duration searches would be successful, it is likely that these technologies would be considered more important for more challenging search situations. These apparently unimportant technologies seem especially relevant if a search may extend for several days under high workloads.

As shown in Table II, the highest development priorities include image enhancement, an efficient process for using the UAV in the WiSAR team, and support for height above ground maintenance. All other technologies were low priorities.

An interesting result occurs when the importance and priority rankings are combined. The sum of significant importance and priority rankings is a heuristic representation of the importance and priority of a technology. Taking the product of the heuristic importance and priority rankings yields the data in Table III. Four technologies are evaluated most highly: improved video (consisting of stabilized video and image enhancement), improved process for using the UAV with WiSAR personnel, and height above ground maintenance. In the next section, we briefly discuss some observations on improving the coordination between the UAV and ground searchers.

B. Paradigms for Coordinating UAV and Ground Searchers

The purpose of introducing a new technology is to simplify the mission, improve mission safety, decrease cost, or speed-up the completion of the mission objective. This mission objective includes many different tasks that often have a predetermined process. Therefore, it is necessary to identify the existing processes employed during mission execution while specifying how the *new technology integrates into these existing processes*.

The existing WiSAR processes include the procedures used by a search team to locate a missing person. Searches are directed by an incident commander who coordinates the activities of various search teams. Some of these search teams have technical search specialties including medical training, climbing/rapelling, spelunking, etc. It is likely that UAV-enabled search will require the creation of a new technical search team: the UAV team. How the UAV team interacts with the incident commander and ground searchers is the key question for integrating UAVs into the existing process.

At least three paradigms have emerged in our field tests with members of Utah County Search and Rescue. We will refer to these paradigms as follows: information-only, UAV-led, and ground-led. We now discuss each paradigm. Before doing so, note that UAVs could also be used to provide logistical support in the rescue and recover phase by, for example, scouting paths and entry points through and into rugged areas.

1) Information Only: In the information-only paradigm, the UAV does not directly support a particular ground search team. Rather, the UAV team is assigned an area by the incident commander and then gathers information in this region using, for example, an exhaustive or a priority search plan. The team “covers” the assigned ground, gathers extra information on possible signs, evaluates these signs, and then informs the incident commander. The incident commander can then dispatch a ground crew to the area if the quality of the information merits.

2) UAV-Led: In the UAV-led paradigm, the UAV is directly supported by a ground search team. Since the type and quality of information gathered from the air differs from information on the ground, it may be useful to have a ground team available to evaluate a possible sign. In this paradigm, a path is selected for the UAV to travel by, for example, specifying a series of waypoints. The UAV then travels to these waypoints and the ground team also travels to these waypoints; the pace of the UAV search must approximately match the ground crew,

ξ_i	ξ_j									
	Hard	StVid	Proc	HAG	ImEn	Gmbl	Intrfc	Wpts	OffSrch	IntM/V
Hard	–	7	6	7	7	7	7	7	7	7
StVid	0	–	4	4	5	4	5	6	7	7
Proc	1	3	–	4	4	5	4	4	6	6
HAG	0	3	3	–	4	3	4	6	6	7
ImEn	0	2	3	3	–	4	5	5	7	6
Gmbl	0	3	2	4	3	–	4	5	5	5
Intrfc	0	2	3	3	2	3	–	5	4	4
Wpts	0	1	3	1	2	2	2	–	3	2
OffSrch	0	0	1	1	0	2	3	4	–	4
IntM/V	0	0	1	0	1	2	3	5	3	–

TABLE I

THE NUMBER OF JUDGES WHO RANKED ξ_i (ROW) HIGHER THAN ξ_j (COLUMN) IN IMPORTANCE. STATISTICALLY SIGNIFICANT RESULTS ARE HIGHLIGHTED IN BOLD.

ξ_i	ξ_j									
	Hard	StVid	Proc	HAG	ImEn	Gmbl	Intrfc	Wpts	OffSrch	IntM/V
Hard	–	0	0	2	0	3	2	4	0	0
StVid	7	–	4	7	2	7	6	7	3	2
Proc	7	3	–	7	3	7	5	6	4	2
HAG	5	0	0	–	0	6	3	5	1	0
ImEn	7	5	4	7	–	7	6	7	6	3
Gmbl	4	0	0	1	0	–	2	4	1	0
Intrfc	5	1	2	4	1	5	–	5	2	2
Wpts	3	0	1	2	0	3	2	–	0	0
OffSrch	7	4	3	6	1	6	5	7	–	3
IntM/V	7	5	5	7	4	7	5	7	4	–

TABLE II

THE NUMBER OF JUDGES WHO RANKED ξ_i (ROW) HIGHER THAN ξ_j (COLUMN) IN PRIORITY. STATISTICALLY SIGNIFICANT RESULTS ARE HIGHLIGHTED IN BOLD.

	Technology									
	Hard	StVid	Proc	HAG	ImEn	Gmbl	Intrfc	Wpts	OffSrch	IntM/V
Importance	9	3	2	3	2	0	0	0	0	0
Priority	0	5	4	1	6	0	0	0	4	4
Overall	0	15	8	3	12	0	0	0	0	0

TABLE III

COMBINING IMPORTANCE AND PRIORITY RANKINGS INTO AN OVERALL DEVELOPMENT SCORE OF HIGH PRIORITY AND IMPORTANT TECHNOLOGIES TO BE DEVELOPED: OVERALL = IMPORTANCE \times PRIORITY.

which is achievable by having the UAV perform spirals or sweeps around the path. When a potential sign is detected in the video, an approximate GPS location and a description of the sign (either verbal or possibly in the form of an aerial snapshot) is given to the ground crew. The ground crew then finds the location, perhaps with tactical support from the UAV, and evaluates the sign. The information is then either given to the incident commander, or used to refine the path of the UAV.

3) *Ground-Led*: By contrast to the UAV-led paradigm in which the UAV occasionally requests information from the ground crew, the roles are reversed in the ground-led paradigm. In this latter paradigm, a hasty search team tries to follow either a scent trail (with dogs) or tracks (with man-tracker specialists). The UAV follows the progress of this hasty search team by flying spirals over them. If the track is lost, the hasty team can request visual information from ahead, to the side,

and from behind the current location of the team. While the ground team is searching, the UAV increases the effectual field of view of the ground team. In this way, the UAV increases the amount of information the ground team can use without corrupting the trail. Importantly, the UAV should probably be flown at an altitude where its sound does not interfere with the ground team's ability to call out and listen for a response from the missing person.

VII. SUMMARY

This report presents results of a GDTA and CWA of the Wilderness Search and Rescue problem domain. Building from these analyses, tasks were identified that are required to support wilderness search using a mini-UAV. Using technology that supports these basic tasks, a series of field tests were performed. These field tests identified three key areas that need work before mini-UAVs can be reliably used in actual wilderness searches: improved video presentation, improved coordination of UAV and ground searchers, and improved support for maintaining height above ground. Work is under development to support these three areas.

ACKNOWLEDGEMENTS

The authors thank their colleagues Tim McLain, Randy Beard, and many students from the BYU MAG-ICC, HCI, and Image Processing laboratories for building and maintaining the UAVs, for providing the foundational control algorithms, for implementing image processing algorithms, and for the generalized contour search algorithm. The authors would also like to thank Dennis Eggett from the BYU Statistical Consulting Center for his help in designing the experiment and analyzing the data from the information presentation experiment. The work was partially supported by the National Science Foundation under grant number 0534736, by the Utah Small Unmanned Air Vehicle Center of Excellence, and by a Mentored Environment Grant for Undergraduates from Brigham Young University.

REFERENCES

- [1] A. L. Alexander and C. D. Wickens. Synthetic vision systems: Flightpath tracking, situation awareness, and visual scanning in an integrated hazard display. In *Proceedings of the 13th International Symposium on Aviation Psychology*, Oklahoma City, OK, 2005.
- [2] L. Bainbridge. Ironies of automation. *Automatica*, 19(6):775–779, 1983.
- [3] L. Bainbridge. The change in concepts needed to account for human behavior in complex dynamic tasks. *IEEE Transactions on Systems, Man and Cybernetics—Part A: Systems and Humans*, 27(3):351–359, May 1997. Special issue on human interaction with complex systems.
- [4] D. B. Barber, S. R. Griffiths, T. W. McLain, and R. W. Beard. Autonomous landing of miniature aerial vehicles. In *AIAA Infotech@Aerospace*, number AIAA-2005-6949, 2005.
- [5] R. Beard, D. Kingston, M. Quigley, D. Snyder, R. Christiansen, W. Johnson, T. McLain, and M. A. Goodrich. Autonomous vehicle technologies for small fixed-wing UAVs. *Journal of Aerospace Computing, Information, and Communication*, 2, 2005.
- [6] Randal W. Beard, Derek Kingston, Morgan Quigley, Deryl Snyder, Reed Christiansen, Walt Johnson, Timory McLain, and Michael A. Goodrich. Autonomous vehicle technologies for small fixed-wing uavs. *AIAA Journal of Aerospace Computing, Information, and Communication*, 2(1):92–108, 2004.
- [7] J. L. Burke and R. R. Murphy. Human-robot interaction in USAR technical search: Two heads are better than one. In *Proceedings of the 13th International Workshop on Robot and Human Interactive Communication (RO-MAN)*, Kurashiki, Okayama, Japan, 2004.
- [8] G. L. Calhoun, M. H. Draper, M. F. Abernathy, M. Patzek, and F. Delgado. Synthetic vision system for improving unmanned aerial vehicle operator situation awareness. In J. G. Verly, editor, *Proceedings of SPIE Vol 5802, in Enhanced and Synthetic Vision 2005*, 2003.
- [9] J. Casper and R. R. Murphy. Human-robot interactions during the robot-assisted urban search and rescue response at the world trade center. *IEEE Transactions on Systems, Man and Cybernetics, Part B*, 33(3):367–385, June 2003.
- [10] W. J. Conover. *Practical Nonparametric Statistics*. John Wiley and Sons, New York, 1999.
- [11] J. W. Crandall, M. A. Goodrich, D. R. Olsen Jr., and C. W. Nielsen. Validating human-robot interaction schemes in multi-tasking environments. *IEEE Transactions on Systems, Man and Cybernetics Part A: Systems and Humans*, 35(4), 2005.
- [12] M. L. Cummings. *Designing decision support systems for a revolutionary command and control domains*. Doctoral dissertation, University of Virginia, 2003.
- [13] M. L. Cummings and S. Guerlain. The tactical tomahawk conundrum: Designing decision support systems for revolutionary domains. In *IEEE International Conference on Systems, Man and Cybernetics*, pages 1583–1588, 2003.
- [14] M. L. Cummings and S. Guerlain. Developing operator capacity estimates for supervisory control of autonomous vehicles. In review, Presence, 2005.
- [15] J. L. Drury, J. Richer, N. Rackliffe, and M. A. Goodrich. Comparing situation awareness for two unmanned aerial vehicle human interface approaches. In *Proceedings of the IEEE International Workshop on Safety, Security and Rescue Robotics (SSRR)*, Gaithersburg, Maryland, USA, August 2006.
- [16] M. Endsley, B. Bolte, and D. Jones. *Designing for Situation Awareness: An Approach to User-Centered Design*. Taylor and Francis, London and New York, 2003.
- [17] M. R. Endsley. A survey of situation awareness requirements in air-to-air combat fighters. *International Journal of Aviation Psychology*, 3(2):157–168, 1993.
- [18] T. Fong and C. Thorpe. Vehicle teleoperation interfaces. *Autonomous Robots*, 11(1):9–18, 2001.
- [19] D. D. Gerhardt. Feature-based unmanned air vehicle video euclidean stabilization with local mosaics. Master's thesis, Brigham Young University, Provo, Utah, USA, 2007.
- [20] J. J. Gibson. *The Ecological Approach to Visual Perception*. Houghton Mifflin, Boston, 1979.
- [21] T. Goetzendorf-Grabowski, A. Frydrychewicz, Z. Goraj, and

- S. Suchodolski. MALE UAV design of an increased reliability level. *Aircraft Engineering and Aerospace Technology*, 78(3):226–235, 2006.
- [22] P. A. Hancock, M. Mouloua, R. Gilson, J. Szalma, and T. Oron-Gilad. Is the UAV control ratio the right question? *Ergonomics in Design*, 2006.
- [23] K. J. Hanna, H. S. Sawhney, R. Kumar, Y. Guo, and S. Samarasekara. Annotation of video by alignment to reference imagery. In *Vision Algorithms: Theory and Practice: International Workshop on Vision Algorithms*. Springer, 2000.
- [24] D. B. Kaber and M. R. Endsley. The effects of level of automation and adaptive automation on human performance, situation awareness and workload in a dynamic control task. *Theoretical Issues in Ergonomics Science*, 5(2):113–153, March-April 2004.
- [25] B. O. Koopman. *Search and Screening: General Principles with Historical Applications*. Pergamon Press, 1980. This book has been reprinted in its entirety in 1999 by the Military Operations Research Society, Inc.
- [26] D. Drumm N. Naikar, B. Pearce and P. M. Sanderson. Designing teams for first-of-a-kind, complex systems using the initial phases of cognitive work analysis: Case study. *Human Factors*, 45(2):202–217, 2003.
- [27] D. A. Norman. *The Design of Everyday Things*. Currency Doubleday, 1988. Previously published as *The Psychology of Everyday Things*.
- [28] Donald A. Norman. Human-centered design considered harmful. *Interactions*, 12(4):14–19, 2005.
- [29] Sheriff's Office. Utah county search and rescue webpage. <http://www.co.utah.ut.us/Dept/Sheriff/volunteer.asp>.
- [30] D. R. Olsen and M. A. Goodrich. Metrics for evaluating human-robot interactions. In *Proceedings of PERMIS 2003*, 2003.
- [31] D. R. Olsen, Jr. and S. B. Wood. Fan-out: Measuring human control of multiple robots. In *Proceedings of Human Factors in Computing systems*, pages 231–238, 2004.
- [32] R. Parasuraman, T. B. Sheridan, and C. D. Wickens. A model for types and levels of human interaction with automation. *IEEE Transactions on Systems, Man and Cybernetics – Part A: Systems and Humans*, 30(3):286–297, May 2000.
- [33] M. Plumlee and C. Ware. An evaluation method for linked?? 3D views. In *Proceedings of the International Conference on Coordinated and Multiple Views in Exploratory Visualization*, 2003. Check to see if the title is correct.
- [34] L. J. Prinzel, J. R. Comstock Jr., L. J. Glaab, L. J. Kramer, and J. J. Arthur. The efficacy of head-down and head-up synthetic vision display concepts for retro- and forward-fit of commercial aircraft. *The International Journal of Aviation Psychology*, 14(1):53–77, 2004.
- [35] M. Quigley, M. A. Goodrich, and R. W. Beard. Semi-autonomous human-UAV interfaces for fixed-wing mini-UAVs. In *Proceedings of the International Conference on Intelligent Robots and Systems*, 2004. To appear.
- [36] M. Quigley, M. A. Goodrich, S. Griffiths, A. Eldredge, and R. W. Beard. Target acquisition, localization, and surveillance using a fixed-wing, mini-uav and gimbaled camera. In *Proceedings of the IEEE International Conference on Robotics and Automation*, Barcelona, Spain, 2005.
- [37] J. A. Ratches, C. P. Walters, R. G. Buser, and B. D. Guenther. Aided and automated target recognition based upon sensory inputs from image forming systems. *IEEE Transactions on Pattern Analysis and Machine Intelligence*, 19(9):1004–1019, September 1997.
- [38] J. Redding, T. W. McLain, R. W. Beard, and C. Taylor. Vision-based target localization from a fixed-wing miniature air vehicle. In *Proceedings of the American Control Conference*, 2006.
- [39] N. B. Sarter and D. D. Woods. How in the world did we ever get into that mode? Mode error and awareness in supervisory control. *Human Factors*, 37(1):5–19, 1995.
- [40] T. J. Setnicka. *Wilderness Search and Rescue*. Appalachian Mountain Club, 1980.
- [41] T. B. Sheridan. *Telerobotics, Automation, and Human Supervisory Control*. MIT Press, 1992.
- [42] T. B. Sheridan. *Humans and Automation: System Design and Research Issues*. John Wiley and Sons, 2002.
- [43] T. B. Sheridan and W. L. Verplank. Human and computer control of undersea teleoperators. Technical report, MIT Man-Machine Systems Laboratory, 1978.
- [44] K. S. Tao, G. K. Tharp, W. Zhang, and A. T. Tai. A multi-agent operator interface for unmanned aerial vehicles. In *Proceedings 18th Digital Avionics Systems Conference*, 1999.
- [45] K. Vicenti. *Cognitive Work Analysis: Toward Safe, Productive and Healthy Computer-Based Work*. Lawrence Erlbaum Associates, 1999.
- [46] C. D. Wickens, O. Olmos, A. Chudy, and C. Davenport. Aviation display support for situation awareness. Technical Report ARL-97-10/LOGICON-97-2, Aviation Research Lab, University of Illinois at Urbana-Champaign, 1995.
- [47] Christopher D. Wickens and Justin G. Hollands. *Engineering Psychology and Human Performance*. Prentice-Hall, New Jersey, third edition, 2000.
- [48] D. D. Woods and S. W. A. Dekker. Anticipating the effects of technological change: A new era of dynamics for human factors. *Theoretical Issues in Ergonomic Science*, 1(3):272–282, 2000.
- [49] D. D. Woods, J. Tittle, M. Feil, and A. Roesler. Envisioning human-robot coordination in future operations. *IEEE Transactions on Systems, Man and Cybernetics, Part A*, 34(6):749–756, November 2004.